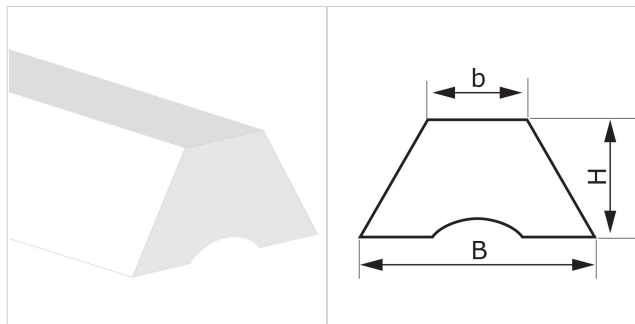

CODE ES638
TYPE
K8 U HP S W
DESCRIPTION

Profiles mainly fitted on conveyor belts as guides.

PRODUCT SYSTEM 

TECHNICAL SPECIFICATIONS

Material Polyurethane (TPU) - HP® system

Hardness 70 ±5 Sh.A

Colour White

Base Grooved

B Upper base 8.0 mm 0.31 in.

b Bottom base 5.0 mm 0.20 in.

H Height 5.0 mm 0.20 in.

Weight 31 gr/m 0.028 oz/in.

Minimum pitch

■ longitudinal 40 mm 1.6 in.

■ transversal 40 mm 1.6 in.

 Minimum pulley diameters⁽¹⁾

■ longitudinal-driving side 40 mm 1.6 in.

■ longitudinal-conveying side 50 mm 2.0 in.

■ transversal-conveying side --- mm --- in.

⁽¹⁾ Minimum pulley diameters referred to environment conditions of 20°C

 Temperature resistance ⁽²⁾ min. -30 °C -22 °F

max. 70 °C 158 °F

⁽²⁾ Use with limit values may reduce its life

Roll/bar sizes 300.0 m 984.0 ft

COMPLIANCES

 REACH EC 1907/2006 Regulation and Amendments
 EC 1935/2004 Regulation and Amendments
 EC 2023/2006 Regulation and Amendments
 EU 10/2011, 2017/752 Regulation and Amendments
 HACCP (Hazard Analysis and Critical Control Points)
 FDA (Food and Drug Administration)
 NSF/ANSI 3-A 14159-3-2014 Regulation and Amendments
 HALAL (World Halal Authority)

METHOD OF APPLICATION

- Hot air welding
- High frequency welding

NOTES

Issue: 22-01-2020

Last Update: 31-08-2020

DISCLAIMER

The information contained in this document describes the features of the CHIORINO product as tested in a laboratory environment at a temperature of +23 degrees °C at 50% relative humidity. It does not necessarily reflect the conditions of industrial use and it does not guarantee the product to be suitable for certain applications. The client remains liable for the proper selection and correct use of the CHIORINO product. CHIORINO cannot be held responsible should damages arise from the use of its products. Necessary alterations to this data can be made without prior notice.