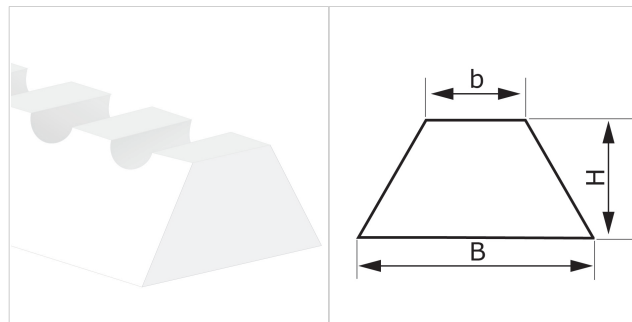

CODE ES59
TYPE
KN10 P W
DESCRIPTION

Knotched profile can be used on smaller roller diameters.

TECHNICAL SPECIFICATIONS

Material	Polyvinyl chloride (PVC)		
Hardness	60 ±5 Sh.A		
Colour	White		
Base	Flat		
B Upper base	10.0 mm	0.39	in.
b Bottom base	6.0 mm	0.24	in.
H Height	6.0 mm	0.24	in.
Weight	50 gr/m	0.044	oz/in.
Minimum pitch			
■ longitudinal	40 mm	1.6	in.
■ transversal	40 mm	1.6	in.
Minimum pulley diameters ⁽¹⁾			
■ longitudinal-driving side	40 mm	1.6	in.
■ longitudinal-conveying side	65 mm	2.6	in.
■ transversal-conveying side	--- mm	---	in.
⁽¹⁾ Minimum pulley diameters referred to environment conditions of 20°C			
Temperature resistance ⁽²⁾	min.	-10 °C	14 °F
	max	60 °C	140 °F
⁽²⁾ Use with limit values may reduce its life			
Roll/bar sizes	300.0 m	984.0	ft

COMPLIANCES

REACH EC 1907/2006 Regulation and Amendments
FDA (Food and Drug Administration)

METHOD OF APPLICATION

- Hot air welding
- High frequency welding

NOTES

Issue: 22-01-2020

Last Update: 22-01-2020

DISCLAIMER

The information contained in this document describes the features of the CHIORINO product as tested in a laboratory environment at a temperature of +23 degrees °C at 50% relative humidity. It does not necessarily reflect the conditions of industrial use and it does not guarantee the product to be suitable for certain applications. The client remains liable for the proper selection and correct use of the CHIORINO product. CHIORINO cannot be held responsible should damages arise from the use of its products. Necessary alterations to this data can be made without prior notice.