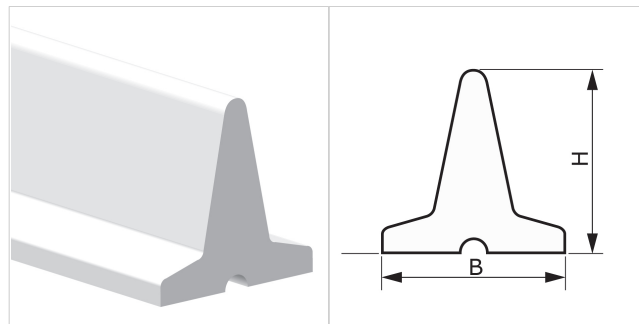

CODE ES407
TYPE
T70 W
DESCRIPTION

PVC lateral profile, straight.

TECHNICAL SPECIFICATIONS

Material	Polyvinyl chloride (PVC)		
Hardness	60 ±5 Sh.A		
Colour	White		
Base	Grooved		
B Upper base	27.0 mm	1.06	in.
b Bottom base	---	---	in.
H Height	70.0 mm	2.76	in.
Weight	765 gr/m	0.680	oz/in.
Minimum pitch			
■ longitudinal	---	---	in.
■ transversal	55 mm	2.2	in.
Minimum pulley diameters ⁽¹⁾			
■ longitudinal-driving side	---	---	in.
■ longitudinal-conveying side	---	---	in.
■ transversal-conveying side	100 mm	3.9	in.
⁽¹⁾ Minimum pulley diameters referred to environment conditions of 20°C			
Temperature resistance ⁽²⁾	min.	-10 °C	14 °F
	max	60 °C	140 °F
⁽²⁾ Use with limit values may reduce its life			
Roll/bar sizes	2.4 m	7.9	ft

COMPLIANCES

 REACH EC 1907/2006 Regulation and Amendments
 FDA (Food and Drug Administration)

METHOD OF APPLICATION

- High frequency welding

NOTES

Issue: 22-01-2020

Last Update: 22-01-2020

DISCLAIMER

The information contained in this document describes the features of the CHIORINO product as tested in a laboratory environment at a temperature of +23 degrees °C at 50% relative humidity. It does not necessarily reflect the conditions of industrial use and it does not guarantee the product to be suitable for certain applications. The client remains liable for the proper selection and correct use of the CHIORINO product. CHIORINO cannot be held responsible should damages arise from the use of its products. Necessary alterations to this data can be made without prior notice.