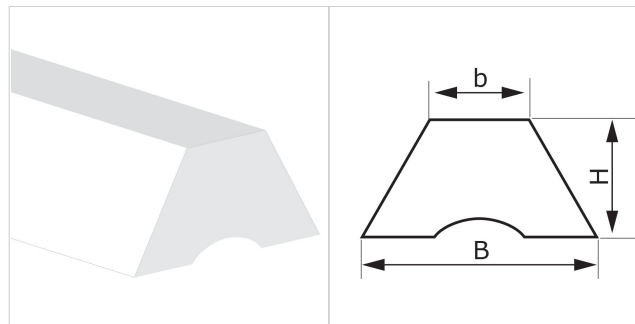

CODE ES26
TYPE
K10 U W
DESCRIPTION

Profiles mainly fitted on conveyor belts as guides.

TECHNICAL SPECIFICATIONS

Material	Polyurethane (TPU)		
Hardness	70 ±5 Sh.A		
Colour	White		
Base	Grooved		
B Upper base	10.0 mm	0.39	in.
b Bottom base	6.0 mm	0.24	in.
H Height	6.0 mm	0.24	in.
Weight	46 gr/m	0.041	oz/in.
Minimum pitch			
■ longitudinal	40 mm	1.6	in.
■ transversal	40 mm	1.6	in.
Minimum pulley diameters ⁽¹⁾			
■ longitudinal-driving side	65 mm	2.6	in.
■ longitudinal-conveying side	105 mm	4.1	in.
■ transversal-conveying side	--- mm	---	in.
⁽¹⁾ Minimum pulley diameters referred to environment conditions of 20°C			
Temperature resistance ⁽²⁾	min.	-20 °C	-4 °F
	max	60 °C	140 °F
⁽²⁾ Use with limit values may reduce its life			
Roll/bar sizes	300.0 m	984.0	ft

COMPLIANCES

 REACH EC 1907/2006 Regulation and Amendments
 EC 1935/2004 Regulation and Amendments
 EC 2023/2006 Regulation and Amendments
 EU 10/2011, 2023/1442 Regulation and Amendments
 HACCP (Hazard Analysis and Critical Control Points)
 FDA (Food and Drug Administration)

METHOD OF APPLICATION

- Hot air welding
- High frequency welding

NOTES

Issue: 22-01-2020

Last Update: 22-01-2020

DISCLAIMER

The information contained in this document describes the features of the CHIORINO product as tested in a laboratory environment at a temperature of +23 degrees °C at 50% relative humidity. It does not necessarily reflect the conditions of industrial use and it does not guarantee the product to be suitable for certain applications. The client remains liable for the proper selection and correct use of the CHIORINO product. CHIORINO cannot be held responsible should damages arise from the use of its products. Necessary alterations to this data can be made without prior notice.