

T20 U W

DESCRIPTION

Polyurethane lateral profile, straight.

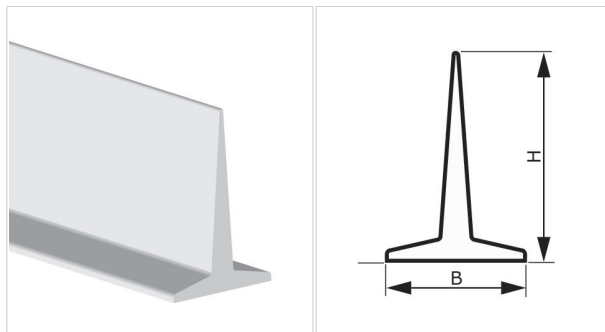

TECHNICAL SPECIFICATIONS

Material	Polyurethane (TPU)		
Hardness	85 ±5 Sh.A		
Colour	White		
Base	Flat		
B Upper base	20.0 mm	0.79	in.
b Bottom base	---	---	in.
H Height	20.0 mm	0.79	in.
Weight	143 gr/m	0.127	oz/in.
Minimum pitch			
■ longitudinal	---	---	in.
■ transversal	45 mm	1.8	in.
Minimum pulley diameters ⁽¹⁾			
■ longitudinal-driving side	---	---	in.
■ longitudinal-conveying side	---	---	in.
■ transversal-conveying side	60 mm	2.4	in.
⁽¹⁾ Minimum pulley diameters referred to environment conditions of 20°C			
Temperature resistance ⁽²⁾	min.	-20 °C	-4 °F
	max	70 °C	158 °F
⁽²⁾ Use with limit values may reduce its life			
Roll/bar sizes	2.4 m	7.9	ft

COMPLIANCES

REACH EC 1907/2006 Regulation and Amendments
 HACCP (Hazard Analysis and Critical Control Points)
 FDA (Food and Drug Administration)

METHOD OF APPLICATION

- High frequency welding

NOTES

PRODUCT CODE ES205

Last Update 22-01-2020

DISCLAIMER

The information contained in this document describes the features of the CHIORINO product as tested in a laboratory environment at a temperature of +23 degrees °C at 50% relative humidity. It does not necessarily reflect the conditions of industrial use and it does not guarantee the product to be suitable for certain applications. The client remains liable for the proper selection and correct use of the CHIORINO product. CHIORINO cannot be held responsible should damages arise from the use of its products. Necessary alterations to this data can be made without prior notice.